

## SLIDE IN REHEAT COIL (HOT WATER | ELECTRIC) FOR CAV & VAV TERMINALS

**NOOO.OO TYPE**





Type designation

Composition type designation:

**N - O - O - O - E - O - O**

Ordering example 1: unit with hot water reheat coil

**N** Position 1: **Product group**

N = air volume control terminals

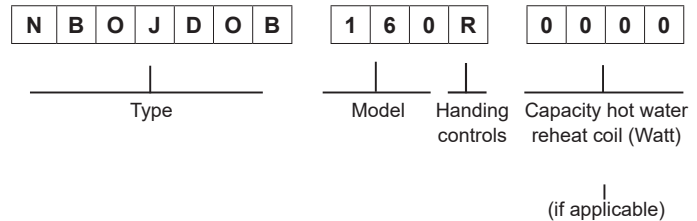

**O** Position 2: **Function**

. = For code, use specified CAV / VAV type designation

**O** Position 3: **Controls (manufacturer)**

O = without controls  
For controls, contact our sales staff

Ordering example 2: unit with electric reheat coil

**O** Position 4: **Distribution plenum**

. = For code, use specified CAV / VAV type designation

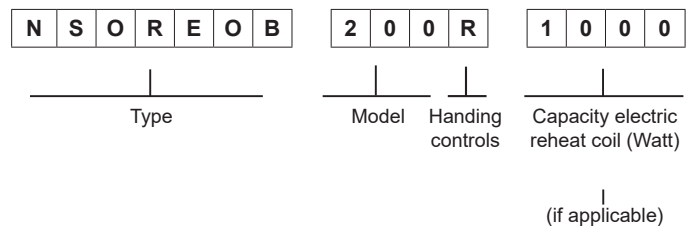

**E** Position 5: **Reheat coil**

- A = 1-row hot water reheat coil
- B = 2-row hot water reheat coil
- D = 4-row hot water reheat coil
- E = 1-stage 230VAC/1-phase electric reheat coil
- F = 2-stage 230VAC/1-phase electric reheat coil
- G = 3-stage 230VAC/1-phase electric reheat coil
- H = 1-stage 400VAC/3-phase electric reheat coil
- J = 2-stage 400VAC/3-phase electric reheat coil
- T = 230VAC-1Ph Modulating control (Thyristor)
- V = 400VAC-3Ph Modulating control (Thyristor)
- 1 = non standard, specify separately

**O** Position 6: **Controls (type & function)**

O = without controls  
For controls, contact our sales staff

**O** Position 7: **Sensor**

O = not applicable

The slide in electric and hot-water reheat coils are applicable for all Barcol-Air CAV / VAV air terminals.

Ordering information:

Standard terminals:

- quantity of terminals
- complete 7 digit code
- terminal size or model
- air volume setting ( $V_{max}$ ,  $V_{min}$  etc)
- control handing (standard right side)
- if applicable, electric reheat coil capacity
- supply or return air

Non standard terminals:

- for non standard terminals a full description and/or drawing are requested.

Type N...A.. / N...B.. / N...D..

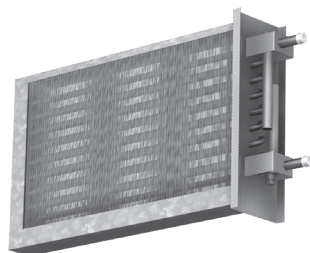

## Application

Types NOOOA00, NOOOB00 and NOOOD00 hot water reheat coils are suitable for incorporation in the HC Barcol-Air VAV and CAV terminals. The dimensions of these "slide in" reheat coils are adapted to the dimensions and the airflow range of the corresponding VAV or CAV terminal size.

## Technical information

### Features:

- Factory fitted into the corresponding VAV or CAV terminal which saves valuable mounting time at site.
- High heat exchange efficiency.
- Available in 1-, 2- or 4-row design.
- Low air side pressure drop.

### Construction:

- Copper tubes with aluminium fins.
- Test pressure 30 bar.
- Max. operating pressure (PN) 12,5 bar.
- Copper tube connections 12 or 15 mm.
- Suitable for all standard controls such as; 2- or 3-Way valves with Thermal-, 3-point or 0-10 VDC actuators.

### Delivery format:

- The reheat coils are factory fitted into the corresponding CAV or VAV terminal.
- The connections are located, as standard, on the right hand side of the terminal when looking in the direction of air flow, unless otherwise requested.
- Coil connections are closed and protected with plastic caps.

## Specify as:

The reheat coils are specified with the corresponding VAV or CAV terminals.

## Selection example:

### Given:

1. Reheat coil size: 160
2. Air flow:  $V = 0.097 \text{ m}^3/\text{s}$
3. Primary(entering) air temp.:  $EAT = 15^\circ\text{C}$
4. Hot water entering temp.:  $EWT = 65^\circ\text{C}$
5. Required capacity :  $P = 1400 \text{ W}$

### Requested:

1. Capacity factor:  $W/^\circ\text{C}$
2. Water flow:  $Q_w \text{ (l/h)}$
3. Water side pressure drop:  $\Delta P_w \text{ (KPa)}$
4. Water side temp.difference:  $\Delta T_w \text{ (}^\circ\text{C)}$
5. Water leaving temperature:  $LWT \text{ (}^\circ\text{C)}$
6. Air side temp. difference:  $\Delta T_A \text{ (}^\circ\text{C)}$
7. Air leaving temperature:  $LAT \text{ (}^\circ\text{C)}$

### Calculation:

1. Capacity factor (see tabel Pn)  
 $C = EWT - EAT = 65 - 15 = 50^\circ\text{C}$   
 $W/C = 1400 / 50 = 28 \text{ W}$

### 2. Water flow ( $Q_w$ )

The required capacity can be achieved by a 1-row coil.

100 l/h results in 26.4 W

175 l/h results in 30 W

By interpolation the final water quantity can be calculated:

$$Q_w = 100 + \frac{(28 - 26.4)}{(30 - 26.4)} \times (175 - 100) = 133.3 \text{ l/h}$$

### 3. Water-side pressure drop $\Delta P_w$

At 100 l/h  $\Delta P_w = 1.46 \text{ kPa}$ , the pressure drop is related to the water flow to the 1.8th:

$$\Delta P_w = \left( \frac{133.3}{100} \right)^{1.8} \times 1.46 = 2.3 \text{ kPa}$$

### 4. Water side temperature difference ( $\Delta T_w$ )

$$\Delta T_w = \frac{w}{Q_w \times 1.16} = \frac{1400}{133.3 \times 1.16} = 9^\circ\text{C}$$

### 5. Hot water leaving temperature (LWT)

$$LWT = EWT - \Delta T_w = 65 - 9 = 56^\circ\text{C}.$$

### 6. Air side temperature difference ( $\Delta T_A$ )

$$\Delta T_A = \frac{P}{V \times 1200} = \frac{1400}{0.097 \times 1200} = 12^\circ\text{C}$$

### 7. Air leaving temperature LAT

$$LAT = EAT + \Delta T_A = 15 + 12 = 27^\circ\text{C}$$

Type N...A.. / N...B.. / N...D..

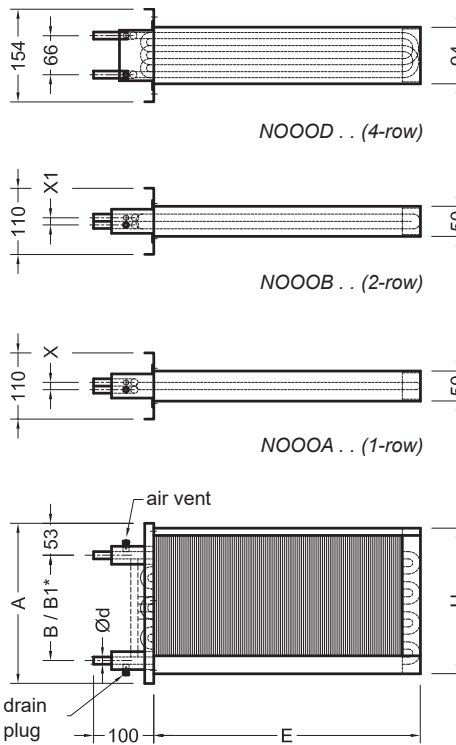
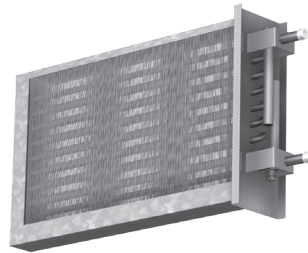

Type NOOOA00, NOOOB00, NOOOD00

Dimensions

Model	100	125	160	200	250	315	355	400
A	226	226	246	266	311	406	406	456
B	125	125	125	175	175	275	275	375
B1*	137.5	137.5	137.5	137.5	187.5	287.5	287.5	375
Ød	12	12	12	12	15	15	15	15
E	320	320	390	490	590	730	810	900
U	202	202	222	242	287	382	382	432
X	0	0	0	12	15	15	15	15
X1	12	12	12	12	15	15	15	15

Notes:  
 1. Dimensions in mm.  
 2. Different sizes available on request.  
 3. \* Size B1 applicable for 2-row and 4-row version.



Type N...E.. / N...F.. / N...G..  
N...H.. / N...J..



## Application

Types N...E., N...F., N...G., N...H.. and N...J.. electrical heating coils are suitable for incorporation in the Barcol-Air VAV and CAV terminals. The dimensions of these "slide in" reheat coils are adapted to the dimensions and the airflow range of the corresponding VAV or CAV terminal size.

## Technical information

### Features:

- Standard available from 500 to 9000 watt capacity.
- Factory fitted into the corresponding VAV or CAV terminal which saves valuable mounting time at site.
- Low air-side pressure loss.
- Available in 1 to 3 stage control type.
- 230VAC/1-phase or 400VAC/3-phase.
- 230VAC/1-phase or 400VAC/3-phase, Thyristor modulating control.

### Construction:

- Heater element: stainless steel, CrNi (1.4541) 8 mm diameter.
- thermal 'cut-out': bimetal disc thermostat, auto reset (55°C) (optional manual reset 70°C).
- Controls enclosure: galvanized sheet steel.

## Delivery format

### Delivery format:

- The reheat coils are factory fitted into the corresponding CAV or VAV terminal.
- The connections are located, as standard, on the right hand side of the terminal when looking in the direction of air flow, unless otherwise requested.
- Standard supplied with 12A relays, suitable for control signal of 24VAC, optional solid state relays or thyristor controls are available.

## Specify as:

### Given:

Reheat coil size 200  
Air flow:  $V = 0.122 \text{ m}^3/\text{s}$   
Primary (entering) air temperature:  
EAT = 15°C  
Required supply (leaving) air temperature  
LAT = 35°C

### Requested:

*The capacity of the electric reheat coil?*

### Calculation:

The required coil capacity can also be calculated using the formula:

$$P = 1200 \times V \times \Delta T$$

$$P = 1200 \times 0.122 \times 20 = 2928 \text{ W}$$

Type N...E.. / N...F.. / N...G..  
N...H.. / N...J..

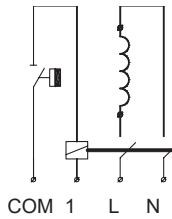
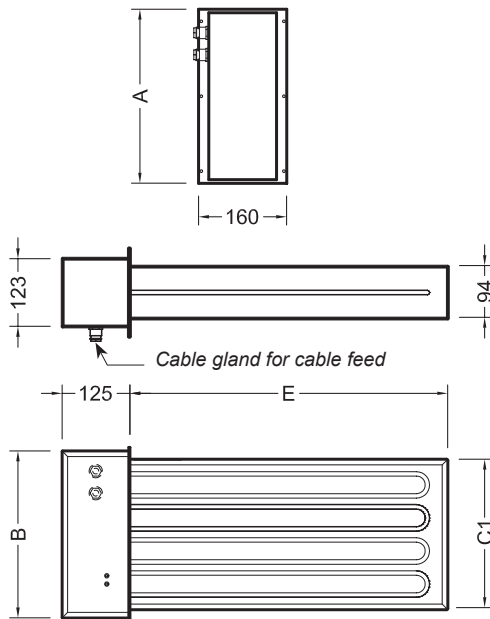

Wiring diagram, 1-stage, 230VAC/1-phase

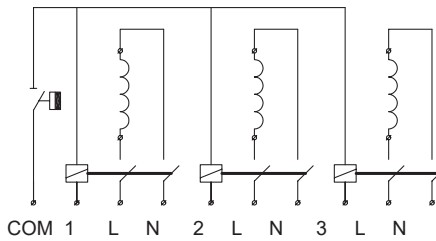

Wiring diagram, 3-stage, 230VAC/1-phase

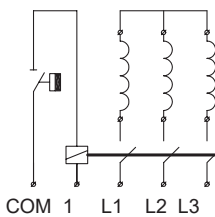

Wiring diagram, 1-stage, 400VAC/3-phase

Type NOOOE00

### Legend:

	= clixon	COM	= common		= coil
	= relais	L 1/2/3	= load		
N	= neutral				

### Dimensions

Model	100	125	160	200	250	315	355	400
A	226	226	246	266	316	406	406	456
B	203	203	203	203	303	303	303	303
C1	183	183	203	223	273	363	363	413
E	307	307	377	377	577	577	577	577

Notes:  
1. Dimensions in mm.  
2. Other sizes available on request.



## Selection table

Type N...E.. / N...F.. / N...G..  
N...H.. / N...J..

Selection table

53 - 4456 m<sup>3</sup>/h

Model	Air velocity at inlet	Air volume		temperature increase due to electric reheat coil										
				1phase/230 VAC (maximum 12 A)						3phase/400 VAC (star)				
				0.5 KW	1 KW	1.5 KW	2 KW	2.5 KW	3 KW	4,5 KW	6 KW	9 KW		
				Δ T °C	Δ T °C	Δ T °C	Δ T °C	Δ T °C	Δ T °C	Δ T °C	Δ T °C	Δ T °C		
100	2	15	31	53	28									
	4	29	62	106	14	28								
	6	44	94	160	9	19	28							
	8	59	125	213	7	14	21	28						
	10	74	156	266	6	11	17	22						
125	2	23	49	84	18									
	4	47	99	168	9	18	27							
	6	70	149	253	6	12	18	24						
	8	94	198	337	4	9	13	18						
	10	117	248	421	4	7	11	14						
160	2	39	82	139	11	21	32							
	4	78	164	279	5	11	16	21	27					
	6	116	246	418	4	7	11	14	18	21				
	8	155	328	558	3	5	8	11	13	16				
	10	194	410	697		4	6	9	11	13				
200	2	61	129	219		14	20	27						
	4	122	258	439		7	10	14	17	20				
	6	183	387	658		5	7	9	11	14				
	8	244	516	878		3	5	7	9	10				
	10	305	645	1097		3	4	5	7	8				
250	2	96	203	345			13	17	22	26				
	4	192	406	690			6	9	11	13	19			
	6	288	609	1035			4	6	7	9	13			
	8	383	812	1380			3	4	5	6	10			
	10	479	1015	1725			3	3	4	5	8			
315	2	153	324	550				11	14	16	24			
	4	306	648	1101				5	7	8	12	16	24	
	6	459	971	1651				4	5	5	8	11	16	
	8	612	1295	2202				3	3	4	6	8	12	
	10	764	1619	2752					3	3	5	7	10	
355	2	195	412	701				9	11	13	19	26		
	4	389	824	1401				4	5	6	10	13	19	
	6	584	1236	2102				3	4	4	6	9	13	
	8	779	1649	2803					3	3	5	6	10	
	10	973	2061	3503						3	4	5	8	
400	2	248	524	891				7	8	10	15	20	30	
	4	495	1049	1783				3	4	5	8	10	15	
	6	743	1573	2674					3	3	5	7	10	
	8	990	2097	3565							4	5	8	
	10	1238	2621	4456							3	4	6	

1. The maximum recommended supply air temperature is 35°C. At this temperature room height, supply air velocity, diffuser type and location has to be taken into account.

2. To calculate the capacity of an electric reheat coil, see selection example on page 5.

3. See price list for standard configurations and capacities.



## OUR TECHNOLOGY | YOUR WELLBEING

**BARCOL-AIR** | AIR DISTRIBUTION

Cantekoogweg 10-12 - 1442 LG Purmerend, The Netherlands

**T** +31 (0)299 689 300 | **E** [export@barcol-air.nl](mailto:export@barcol-air.nl)

[WWW.BARCOL-AIR.NL](http://WWW.BARCOL-AIR.NL)